

Wire-Free Doorbell
Myers MBD-100

User manual

Myers

PREMIUM SMART HOME SYSTEMS
by PARTIZAN

- 1. How to start..... 3**
- 2. Connection and installation 5**
 - 2.1. Main device elements5
 - 2.2. Installation scheme5
 - 2.3. Charger connection scheme.....6
- 3. Adding doorbell to Partizan mobile application 7**
 - 3.1. Download and install Partizan mobile application.....7
 - 3.2. Launch Partizan mobile application and follow instructions7
 - 3.3. Setting up operation modes in Partizan mobile application..... 11
 - 3.3.1. Controls console, appearance 11
 - 3.3.2. Settings menu..... 12
 - 3.3.3. Alarms..... 13
 - 3.3.4. Shared access 13
 - 3.3.5. Delete device..... 14

1. How to start

This device supports **Partizan Cloud Storage** service and **Partizan** mobile application for iOS and Android.

Partizan Cloud Storage benefits:



Your data cannot be stolen or damaged.



No one can access your devices, live and archived video without your permission.



Access to your account and devices from anywhere in the world. Even mobile Internet is enough.



Partizan app won "**Best Mobile Video Surveillance App 2019**" international award.

To take full advantage of the device, **install Partizan mobile application** for iOS or Android:



Partizan mobile application for iOS:

<https://apps.apple.com/app/partizan/id1473001227>



Partizan mobile application for Android:

<https://play.google.com/store/apps/details?id=com.partizan.pro>

To work with this device you need to **sign in to your cloud account**.

Open the app, use an **existing account** or **create a new one**:

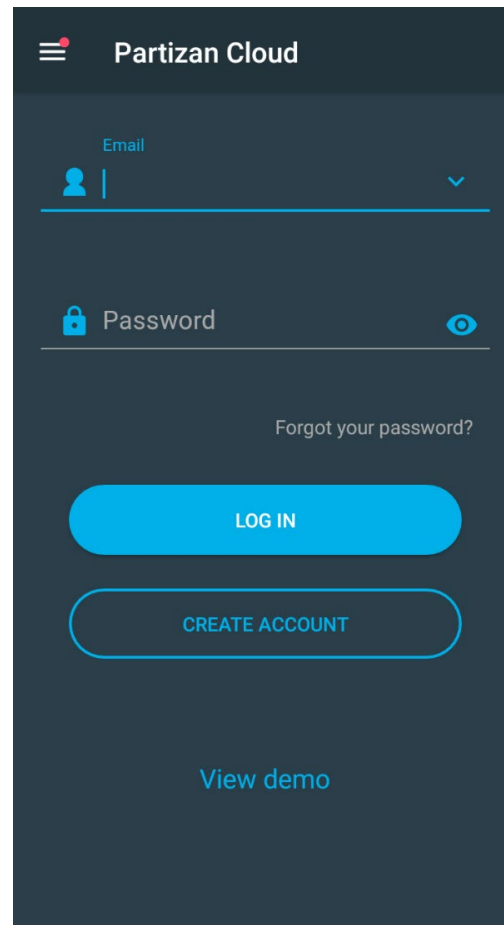
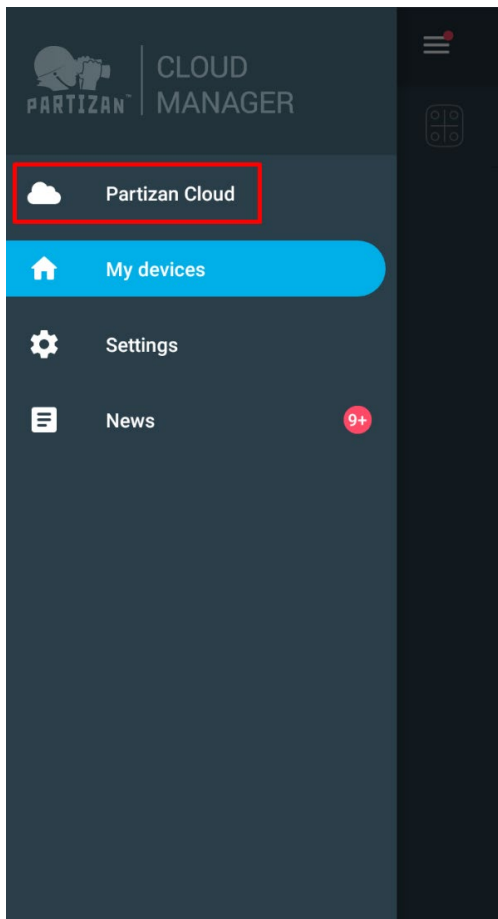
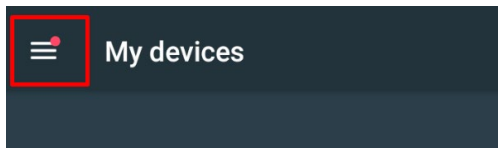

After signing into the cloud account you can go directly to device setting.

If you have any questions,
please contact our technical support:

E-mail: support@partizan.global

Skype: partizan-support

Chat: +420 777 054 888 (Viber, Telegram, WhatsApp)



Technical support working time:
<https://partizan.global/support/technical-support>



Partizan software:
<https://apps.partizan.global/>

2. Connection and installation

2.1. Main device elements

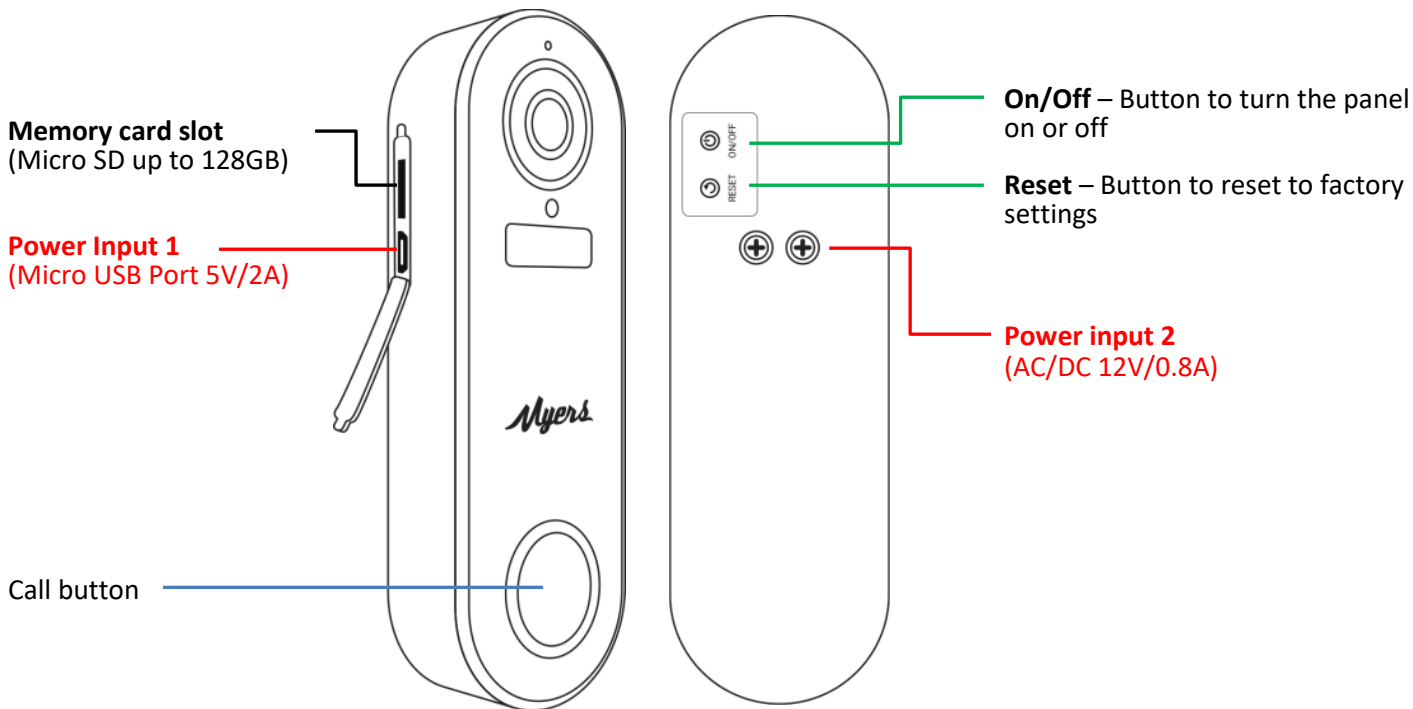

2.2. Installation scheme

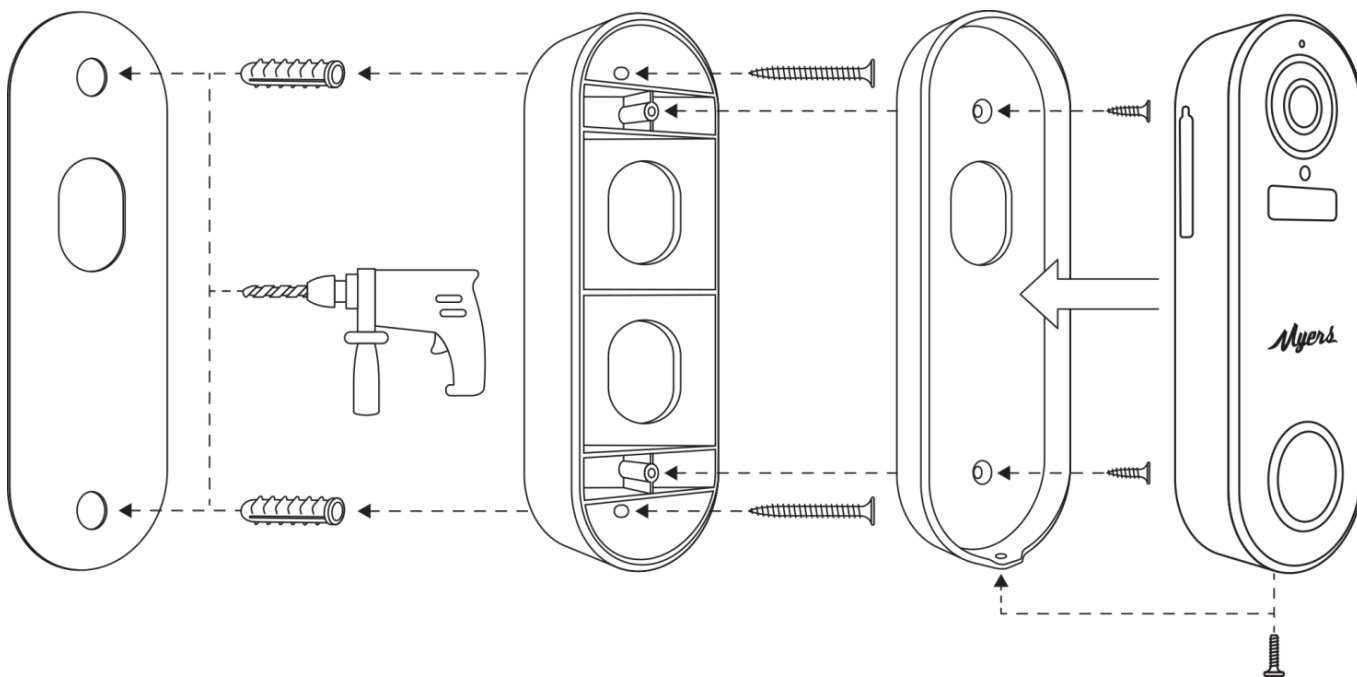

2.3. Charger connection scheme

1. Typical charging scheme using USB chargers.
2. Typical charging scheme using power supply.

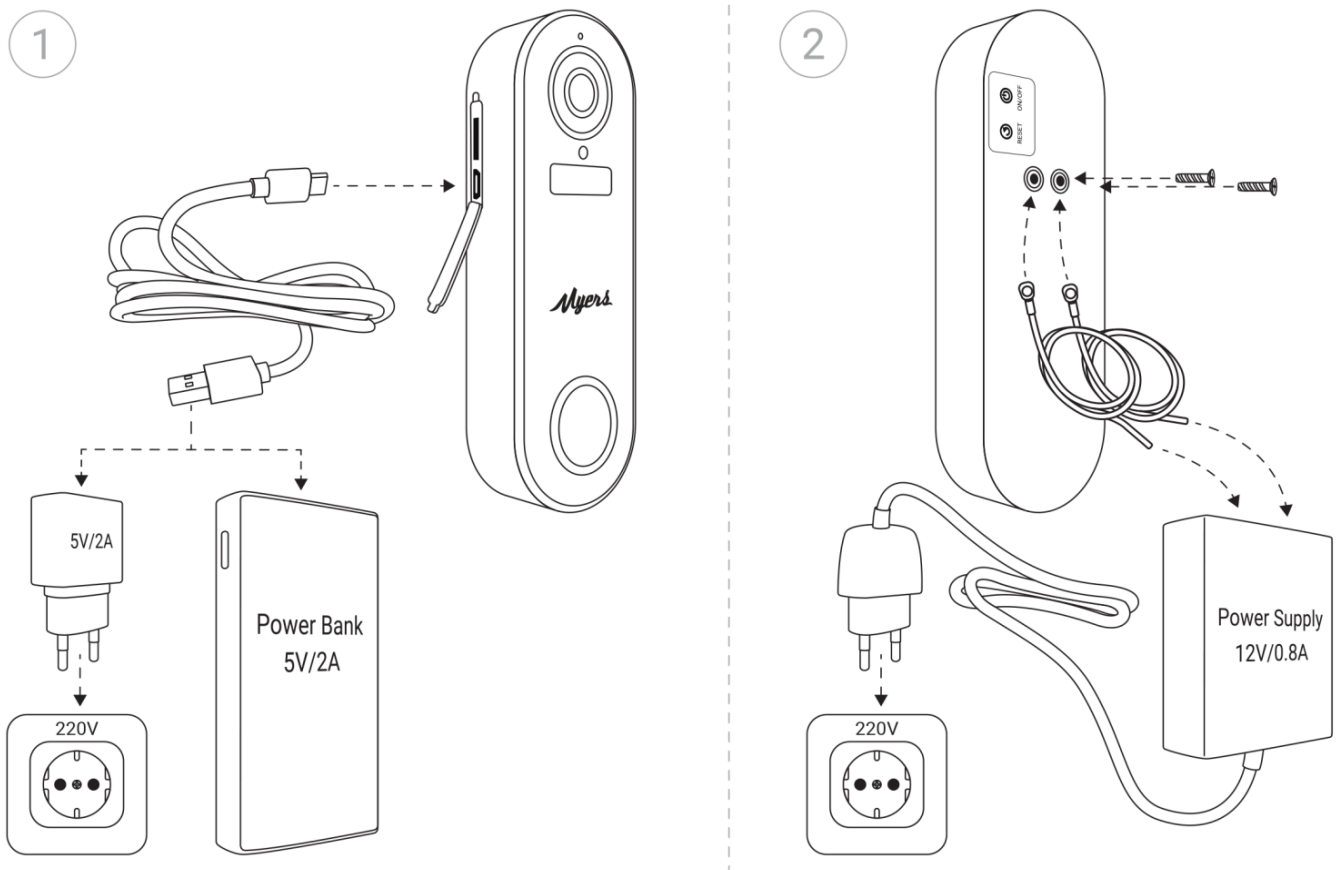

⚠ When connecting the power supply, like it is specified in option 2, the polarity does not matter, the order of connecting the contacts can be any!

3. Adding doorbell to Partizan mobile application

3.1. Download and install Partizan mobile application



Partizan mobile application for iOS:

<https://apps.apple.com/app/partizan/id1473001227>



Partizan mobile application for Android:

<https://play.google.com/store/apps/details?id=com.partizan.pro>

3.2. Launch Partizan mobile application and follow instructions

Press “+” button (in the upper right corner of the screen for iOS or in the lower right corner of the screen for Android).

Press “Add device”.

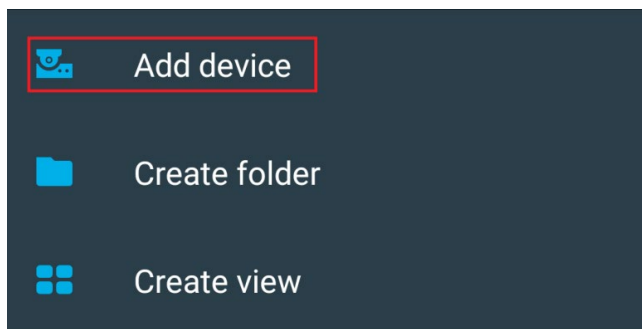

Chose device connection type “Wireless Connect”.

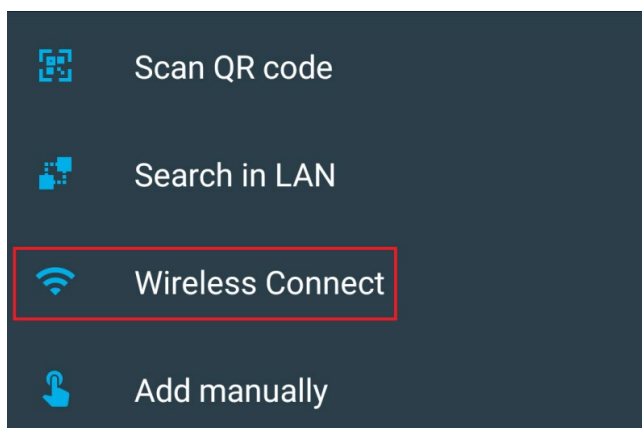

Choose “**Doorbell**” device.



To work with this type of device you need to **sign in to your cloud account**. Use an **existing account** or **create a new one**.

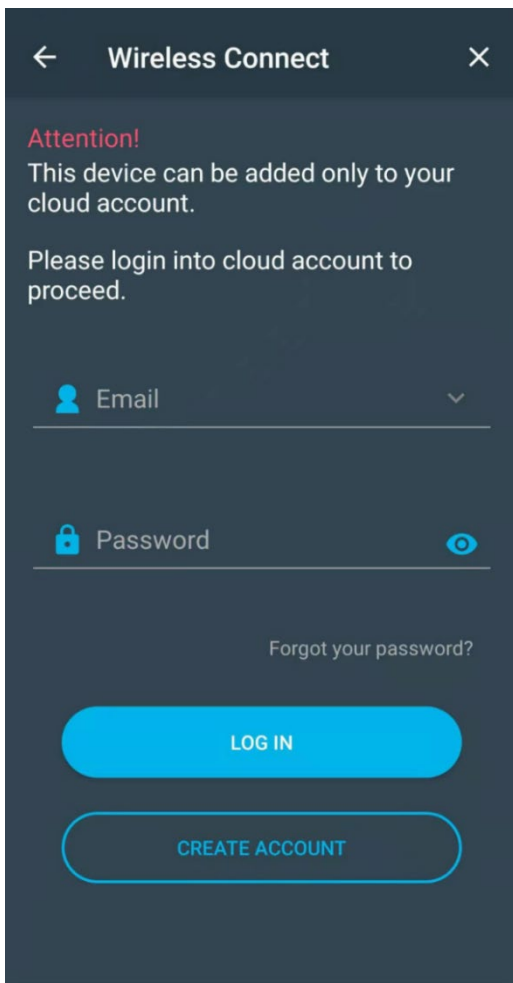

Enter your Wi-Fi network registration data of (network name and password) to which the mobile phone is connected.

The network standard must be 2.4GHz!

Press **“Next”**.

Switch the device on.

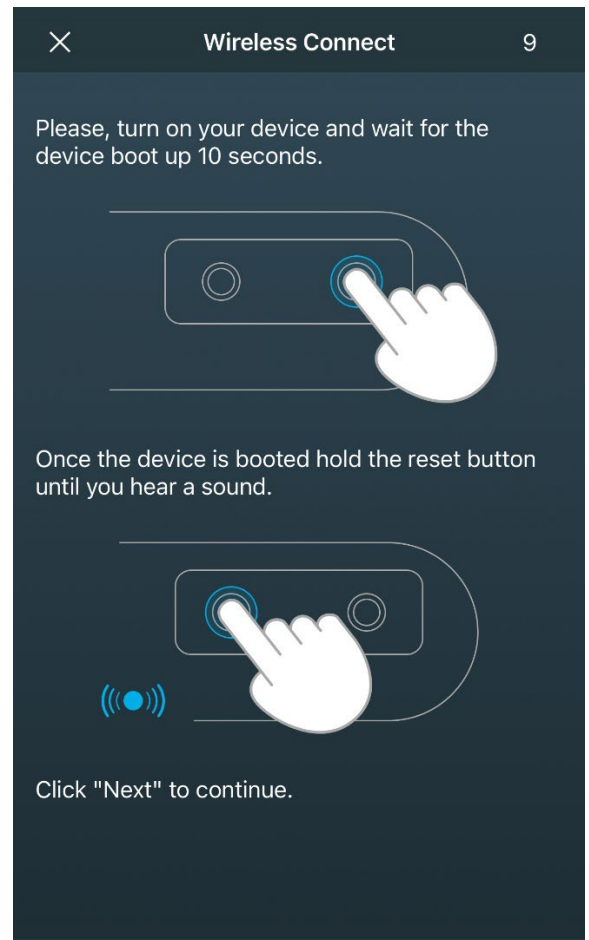
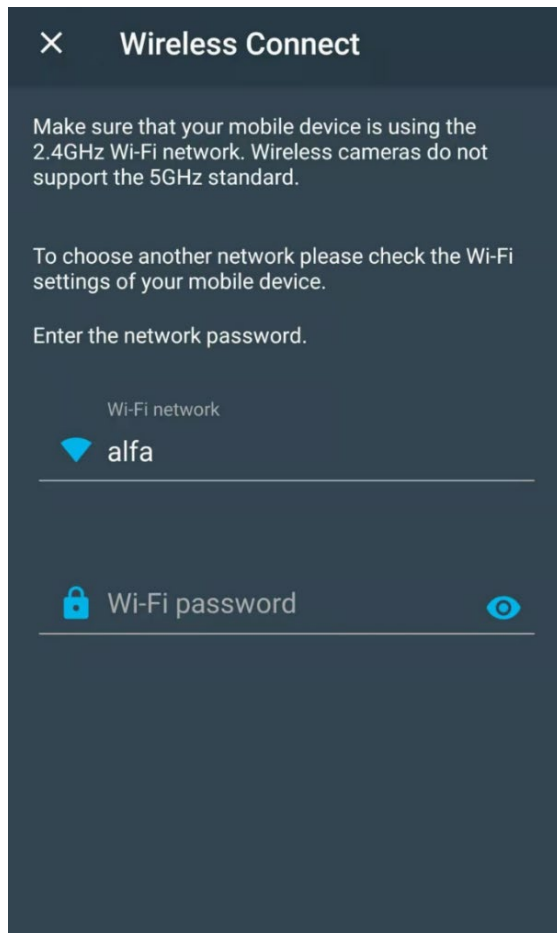

Wait 10 seconds for the device to boot.
Hold the **“Reset”** button until you hear a beep.
Press **“Next”**.

✕ Wireless Connect

Please, show the QR code displayed on the screen to the device at a distance of 10-15cm.



Once you hear the sound click "Next" to continue.

NEXT >

Scan generated QR code by the doorbell at a distance of 10-15 cm, as soon as the device reads it, you hear a beep.

After the beep, press "**Next**".

The doorbell will receive Wi-Fi network registration data, get connected and will be added to your cloud account devices list.

✕ Wireless Connect 118

Sending Wi-Fi network settings...



3.3. Setting up operation modes in Partizan mobile application.

Choose the doorbell in the list of added devices.



3.3.1. Controls console, appearance

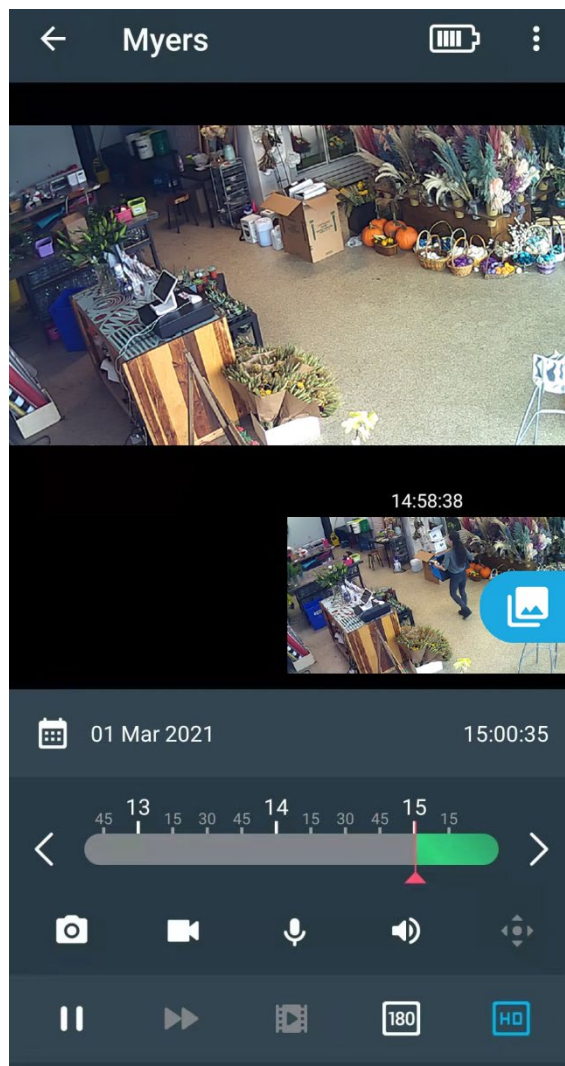



- battery level

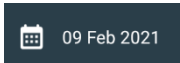

09 Feb 2021

- date selection for viewing the archive

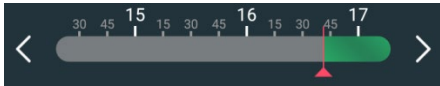

- timeline



- make a snapshot



- record video



- turn on the microphone



- turn on speaker



- PTZ controls



- pause playback



- fast view



- upload video fragment



- flip the image 180 °



- high definition

3.3.2. Settings menu

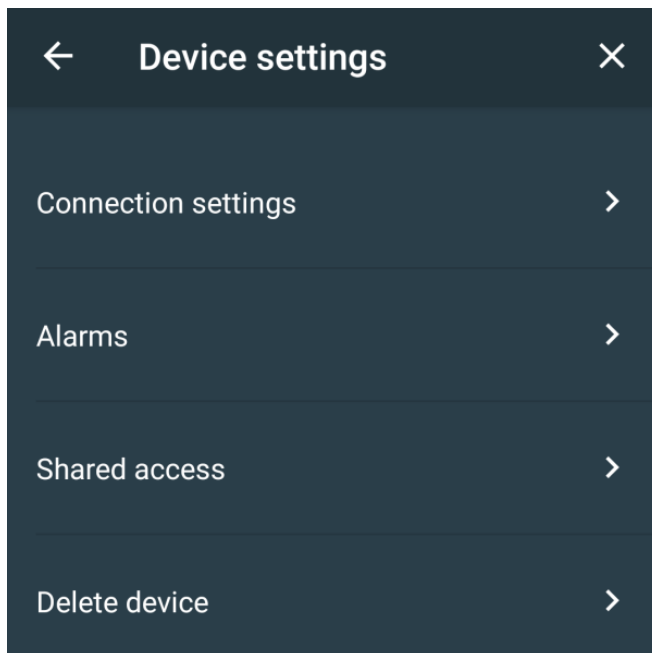

3.3.3. Alarms

This item is used to configure the alarm settings.

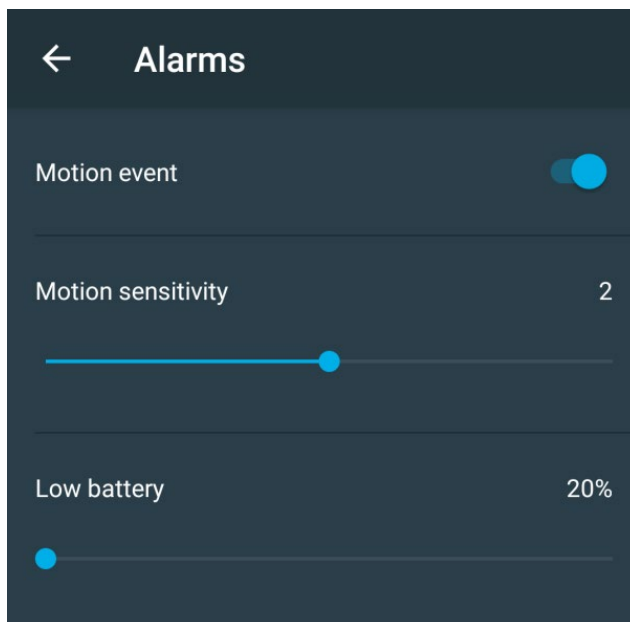

Motion event – activation of motion detection.

Motion sensitivity – setting the sensitivity of the motion sensor.

Low battery – setting low level of battery charge.

3.3.4. Shared access

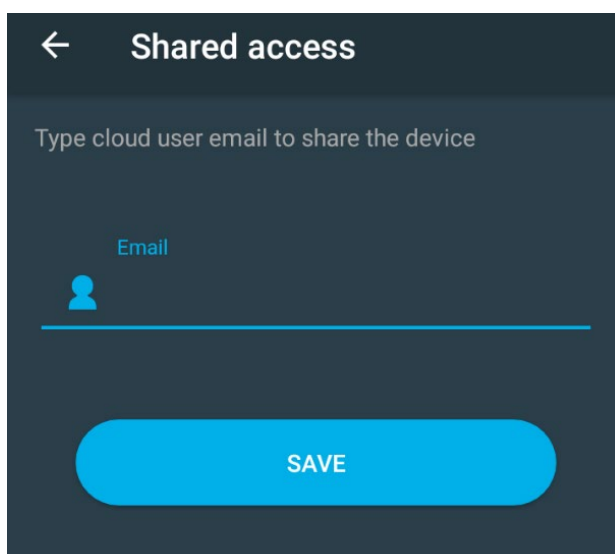

3.3.5. Delete device

Deleting of the device.

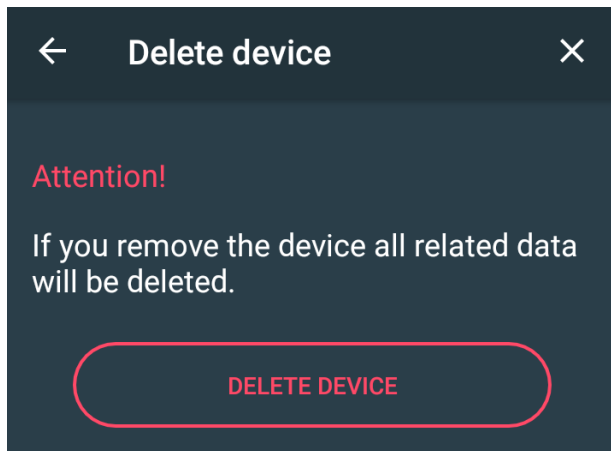

To delete press “Delete device” button.

Technical support:

E-mail: support@partizan.global

Skype: partizan-support

Chat: +420 777 054 888 (Viber, Telegram, WhatsApp)



Technical support working time:

<https://partizan.global/support/technical-support>

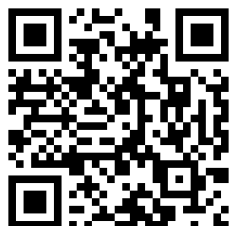

Partizan software:

<https://apps.partizan.global/>